

## SPICE thermal model

BUK7Y35-55B

Symbol	Parameter	Conditions	Min	Typ	Max	Unit
$R_{th(j-mb)}$	thermal resistance from junction to mounting base		-	-	2.53	K/W

$C_{th1}$	1.131E-02 F
$C_{th2}$	1.786E-03 F
$C_{th3}$	4.474E-04 F
$C_{th4}$	1.121E-04 F
$C_{th5}$	2.808E-05 F
$C_{th6}$	7.035E-06 F
$C_{th7}$	1.763E-06 F
$C_{th8}$	4.416E-07 F
$R_{th1}$	1.591E+00 $\Omega$
$R_{th2}$	6.822E-01 $\Omega$
$R_{th3}$	1.843E-01 $\Omega$
$R_{th4}$	4.977E-02 $\Omega$
$R_{th5}$	1.344E-02 $\Omega$
$R_{th6}$	3.631E-03 $\Omega$
$R_{th7}$	9.809E-04 $\Omega$
$R_{th8}$	2.650E-04 $\Omega$

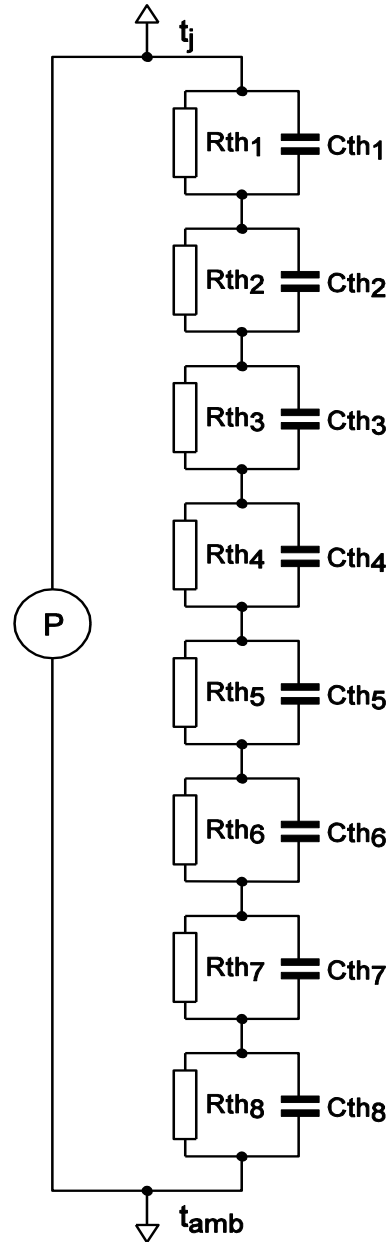

001aal768

Part: BUK7Y35-55B  
 Version: 1  
 Date: 23-3-2010  
 Rth: 2.53